

Triangular pressed flanged location units with clamp
bearing d = 25 to 35 mm

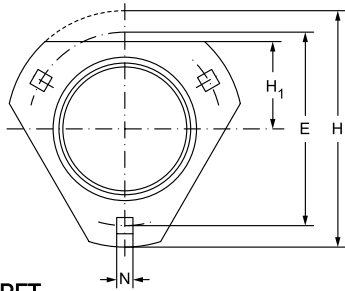

PFT

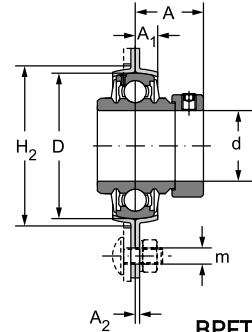
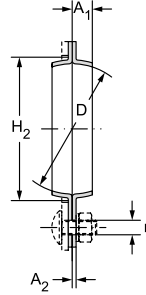

BPFT-EC

12.13.10

Main dimensions										
d	D	H	E	H ₁	H ₂	A	A ₁	A ₂	N	m
mm										
25	52	99,5	76	-	60	-	9	2	9	M8
	52	99,5	76	-	60	-	9	2	9	M8
30	62	112,5	90,5	-	71	-	9,5	2,5	11	M10
	62	112,5	90,5	-	71	-	9,5	2,5	11	M10
35	72	122	100	-	81	-	10	2,5	11	M10
	72	122	100	-	81	-	10	2,5	11	M10
20	47	90	71	-	55	-	8	2	9	M8
40	80	148	119	-	91	-	10.8	3.5	13.5	M10
	80	148	119	-	91	-	10.8	3.5	13.5	M10



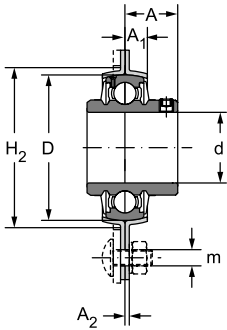

BPFT

When using UE type bearings in FB hubs, the hub system designation is FBE When using UD type bearings in FB hubs, the hub system designation is FBD When using US type bearings in FB hubs, the hub system designation is FBS

Basic load rating		Weight	Designation of		
dynamic C_r	static C_{or}		unit	housing	bearing
kN		kg			
10.78	6.98	0,36	FBA205	FB205	UA205
10.78	6.98	0,3	FBC205	FB205	UC205
14.97	10.04	0,58	FBA206	FB206	UA206
14.97	10.04	0,5	FBC206	FB206	UC206
19.75	13.67	0,81	FBA207	FB207	UA207
19.75	13.67	0,67	FBC207	FB207	UC207

Round pressed flanged location units with clamp bearing $d = 20$ to 35 mm

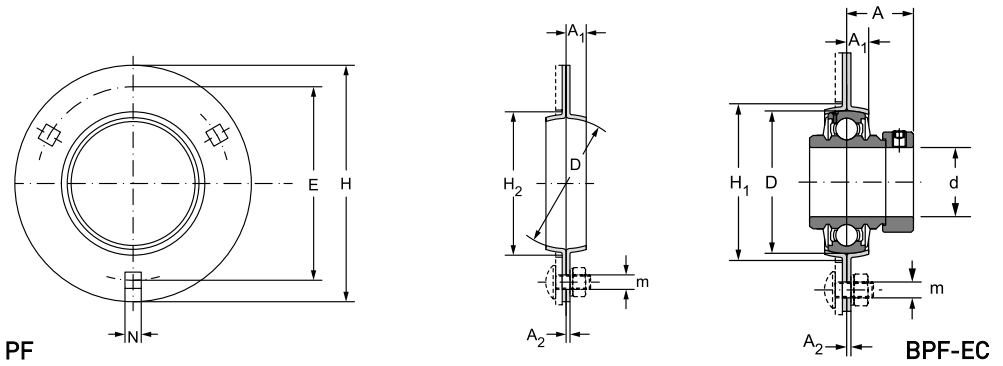

Main dimensions									
d	D	H	E	H ₂	-	A ₁	A ₂	N	m
mm									
20	47	90	71	55	-	8	2	9	M10
25	52	95	76	60	-	8,5	2	9	M10
	52	95	76	60	-	8,5	2	9	M10
30	62	113	90	71	-	8,7	2,5	11	M10
	62	113	90	71	-	8,7	2,5	11	M10
35	72	122	100	81	-	9,5	2,5	11	M10
	72	122	100	81	-	9,5	2,5	11	M10
40	80	148	119	81	-	10,8	3,5	13,5	M12
	80	148	119	81	-	10,8	3,5	13,5	M12

12.13.11



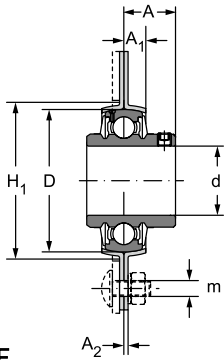

BPF

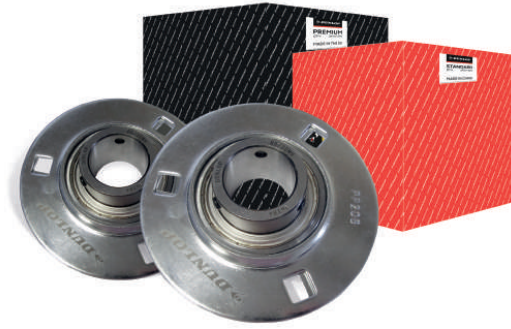

When using UE type bearings in FE hubs, the hub system designation is FEE When using UD type bearings in FE hubs, the hub system designation is FED When using US type bearings in FE hubs, the hub system designation is FES

Basic load rating		Weight	Designation of		
dynamic C_r	static C_{or}		unit	housing	bearing
kN		kg			
12,7	6,5	0,27	BPF 4/20	PF4	B4/20
14	7,9	0,4	BPF 5/25 EC	PF5	B5/25 EC
14	7,9	0,35	BPF 5/25	PF5	B5/25
19,4	11,2	0,65	BPF 6/30EC	PF6	B6/30 EC
19,4	11,2	0,55	BPF 6/30	PF6	B6/30
25,6	15,2	0,86	BPF 7/35 EC	PF7	B7/35 EC
25,6	15,2	0,86	BPF 7/35	PF7	B7/35
22.71	15.94	0.94	BPF 8/40 EC	PF8	B8/40 EC
22.71	15.94	0.86	BPF 8/40	PF8	B8/40

Upright sheet metal location units with clamp bearing $d = 25$ to 35 mm

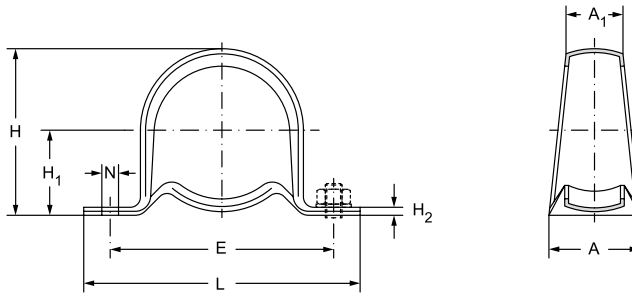

PP

Main dimensions									
d	D	A	A ₁	E	L	H	H ₁	H ₂	N
mm									
20	47	25	16	76	98	50.4	25.4	3	9.5
25	52	32	21.5	86	108	56.5	28.6	4	11.5
30	62	38	23.8	95	117	66.3	33.3	4	11.2
35	72	38	27	106	130	78.2	39.7	5	11.2
40	80	44	28	120	148	85.8	43.7	5	12

12.13.12



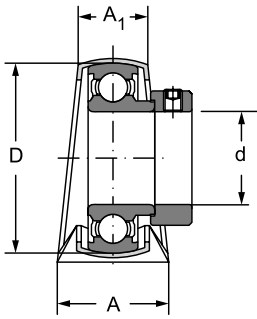

BPP-EC

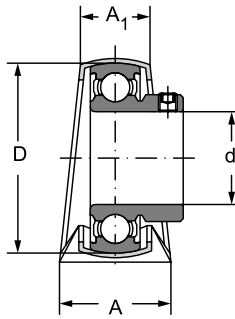

BPP

SAD type hub assemblies use UD bearings
 BPP-EC type hub assemblies use UE bearings
 BPP type hub assemblies use US bearings

Basic load rating		Weight	Designation of		
dynamic C_r	static C_{or}		housing	housing with bearing	
kN		kg			
9.88	6.20		PP4	BPP4/20 EC	BPP4/20
10.78	6.48	0.33	PP5	BPP5/25 EC	BPP5/25
14.97	10.04	0.53	PP6	BPP6/30 EC	BPP6/30
19.75	13.67	0.81	PP7	BPP7/35 EC	BPP7/35
22.71	15.94		PP8	BPP8/40 EC	BPP8/40

12:14 The Product Range

Individual products:

Initial selection

To help a designer make an initial selection this page detail the main characteristics and advantages of the different bearing products along with a brief description. More detailed technical information is given in the sections devoted to each specific bearing material.

BU is a metal backed, PTFE (polytetrafluoroethylene) and lead lined, composite bearing material designed to operate without lubrication at temperatures between -200°C and $+280^{\circ}\text{C}$. It can be loaded up to $2250\text{N}/\text{mm}^2$, dependent on conditions.

BU resists most solvents and many industrial liquids and gas including water and oil, most of which improve its performance. It has negligible "stick-slip", is tolerant of dusty environments, and does not accumulate static electricity.

During normal operation, a thin film from the PTFE lining is transferred to the opposing surface and maintained there throughout the working life of the bearing. Therefore, DU bushes cannot be bored, broached or burnished to size after installation unless the application is such that a considerable reduction in the performance of the material can be tolerated. BU is available from stock in the form of wrapped bushes, thrust washers, or strip. The metal backing material is normally mild steel, but a bronze backed version, identified as BU(B), is available where corrosion resistance is important.

BU can be produced without the incorporation of lead into the PTFE lining. In this form the material is identified as DP and is intended for applications where the possible contamination of food products by the lead in BU is unacceptable and for lubricated applications where the lead in BU may be subject to corrosive attack.

BX is a steel backed, acetal co-polymer lined, composite bearing material designed for marginally lubricated operation and is particularly suitable where continuous oil lubrication is uneconomic or inappropriate.

The bearing surface may be supplied indented for grease lubrication or it may be plain for applications where fluid lubrication is available. The indented material surface which should be filled with suitable grease during assembly is designed to provide optimum distribution of the lubricant over the bearing surface. Dependent on conditions, BX can withstand temperatures from -40°C up to 130°C for short periods and specific loads up to $140\text{N}/\text{mm}^2$.

BX is available from stock in the form of wrapped bushes, thrust washers and strip. The wrapped bushes are available in pre-finished or machinable form. The latter may be bored, reamed or broached to size after installation.